



Whale

Munster Simms Engineering Ltd
 Old Belfast Road, Bangor, Co. Down,
 N. Ireland BT19 1LT.
 Tel: 028 91 270531 Fax: 028 91 466421
 www.whalepumps.com Email: sales@whalepumps.com

WHALE® GUSHER® TITAN BILGE PUMPS

Models: BP4402, BP4410 and BP4429

READ CAREFULLY BEFORE INSTALLATION AND USE

To the Fitter. Check that the product is suitable for the intended application, follow installation instructions and ensure operating instructions are passed on to the end user.

To the User. Read the following instructions carefully. (See parts diagram).

APPLICATION

This bilge pump is designed to exhaust standing water. Output capacity depends on installation conditions and pumping rate. (see Fig. 3)

Users should be aware that capacity may not be sufficient to cope with rapid influx of water.

If it is intended for use for any other purpose or with any other liquid, it is the users' responsibility to ensure that the pump is suitable for the intended use and, in particular, that the materials are fully compatible with the liquids to be used. With all applications it is important that a system of safe working practice is applied to installation, use and maintenance.

INSTALLATION

The Gusher Titan is designed for mounting on or through deck, or on or through bulkhead. The standard model (BP4402) allows considerable flexibility in the choice of handle position in relation to the direction of the flow.

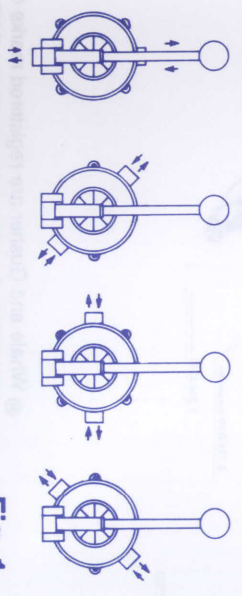
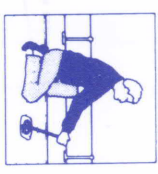

Fig. 1

- To Change Flow Direction:**
- Release the screws on both sides of the clamping ring. Ease off the diaphragm and rotate body to new position relative to the fork and diaphragm.
 - Reassemble diaphragm and clamping ring remembering to tighten the clamping screws evenly on both sides.

Select a suitable position free from obstructions where the pump can be operated efficiently and comfortably.



Avoid installations which require a cockpit locker to be opened in order to operate the pump.

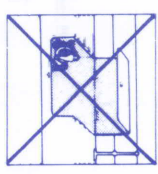

To minimise pumping effort, site the pump halfway (in height) between the strum-box/strainer and hull outlet.

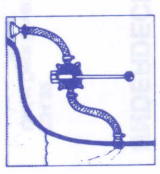

To ensure good priming and flow, avoid sharp bends in pipework and fit a Whale strum-box/strainer (incorporating a non-return valve) which prevents the end of the hose sucking against a flat surface and allows the water level to be reduced to a minimum.

Ensure that the pump is installed to allow easy access for servicing.

For Mounting On Bulkhead: (BP4402)

- Using pump as template, mark off and drill four 1/4" (6mm) holes.

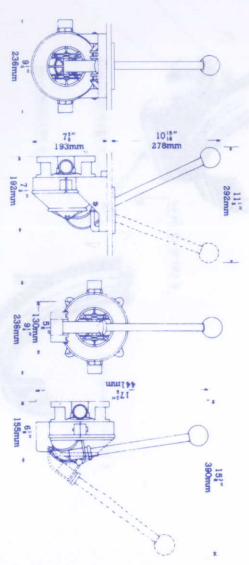

- Check flow direction and secure the pump with 1/4" (6mm) bolts.

- Attach 1.1/2" (38mm) smooth bore reinforced hose with stainless steel worm drive hose clips. Tighten clips to prevent air leaks.
- With thru-hull discharge, make sure that the discharge point is well above the water line.



- Check the installation for air leaks, correct priming and discharge.

For Mounting On Deck (BP4429) or Thru Deck/Bulkhead (BP4410)

- For the on deck or thru deck/bulkhead models, the inlet and outlet directions can be reversed by following the instructions for repositioning the handle.
- For the on deck or thru deck/bulkhead models (BP4410 and BP4429), the deck thickness must be a minimum of 13mm (0.5"), and a maximum of 25mm (1").
- For on deck model BP4429 follow points 1 to 5 of previous instructions.
- With thru deck/bulkhead model (BP4410) a plastic deck plate (DP8904) is supplied with the pump.

- Position pump under deck and check flow direction. Work the rubber gaiter up through the hole until its flange rests on the deck. Secure the six 1/4" (6mm) countersunk mounting screws provided.
- As points 3, 4 and 5 of previous instructions.

OPERATION

The Gusher Titan ensures efficient throughput with an easy pumping action. Full even strokes will obtain the best results. The detachable handle is fitted with a lanyard and should be safely secured close to the pump.

Fig. 3 Performance Table
 WHALE GUSHER TITAN
 OUTPUT AT 1m LIFT AND 0.5m HEAD

OUTPUT	AT 60 STROKES/MIN.	AT 70 STROKES/MIN.
GALLONS/MIN.	20	23.2
LITRES/MIN.	90	105.6

Performance data is based on factory tests and is typical of what may reasonably be achieved. Actual performance may vary depending on installation and operating conditions.

Inspection:
Regular inspection of the pump is recommended. Rubber components should be replaced if worn or every three years regardless of condition.

Replacement components and Service Kits (SK4400 for clean bilge water and SK4419 for oily bilge water) are available from dealers or direct from the manufacturer. It is recommended that a service kit is kept on board.

Winterising:

At the end of the season, drain all the water in the pipework and pump chamber.

Changing The Diaphragm and Valves:

1. Release screws on both sides of the clamping ring.
2. Remove clamping plate and diaphragm.
3. Remove both circlips from the fulcrum pin and lever to expose the clamping bolt.
4. Remove clamping bolt, noting position of the diaphragm plates.
5. Remove and replace inlet and outlet valves as illustrated in parts diagram.
6. Fit new diaphragm, reassemble pump and test for correct priming and discharge.

ACCESSORIES:

- *DP8904 - Plastic deck plate.
- *SF5425 - Skirting.
- *SB5865 - Top entry strumbox/strainer.
- *SB4222 - Side entry strumbox/strainer.
- *DV5606 - 2-way diverter valve.
- *EB3488 - 90° elbow (male to female).
- *LV1215 - In-line non-return valve.
- *SK4400 - Service Kit Neoprene.
- *SK4419 - Service Kit Nitrile.

HELPFUL HINTS

- Pump fails to prime or chokes:
- Check inlet hose connection is airtight, free from blockages and does not collapse during the suction stroke.
- Inspect diaphragms — replace if damaged.
- Solid objects in the body of the pump may not prevent its operation but should be removed to prevent damage.
- Inspect inlet and outlet valves for blockages. Clear with finger or screwdriver and test.

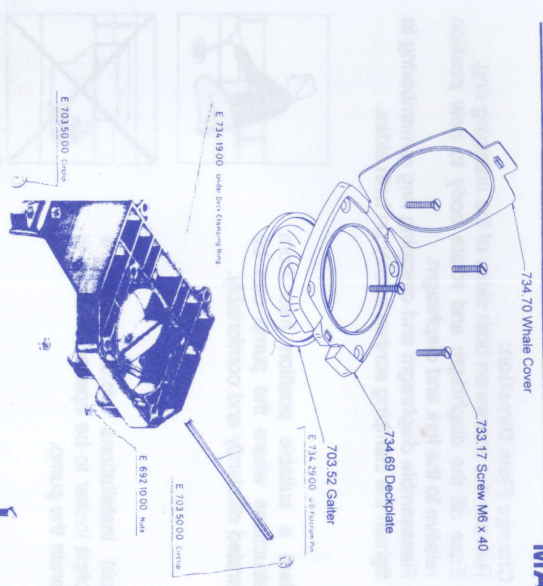

UNDERDECK VERSION



ALL VERSIONS

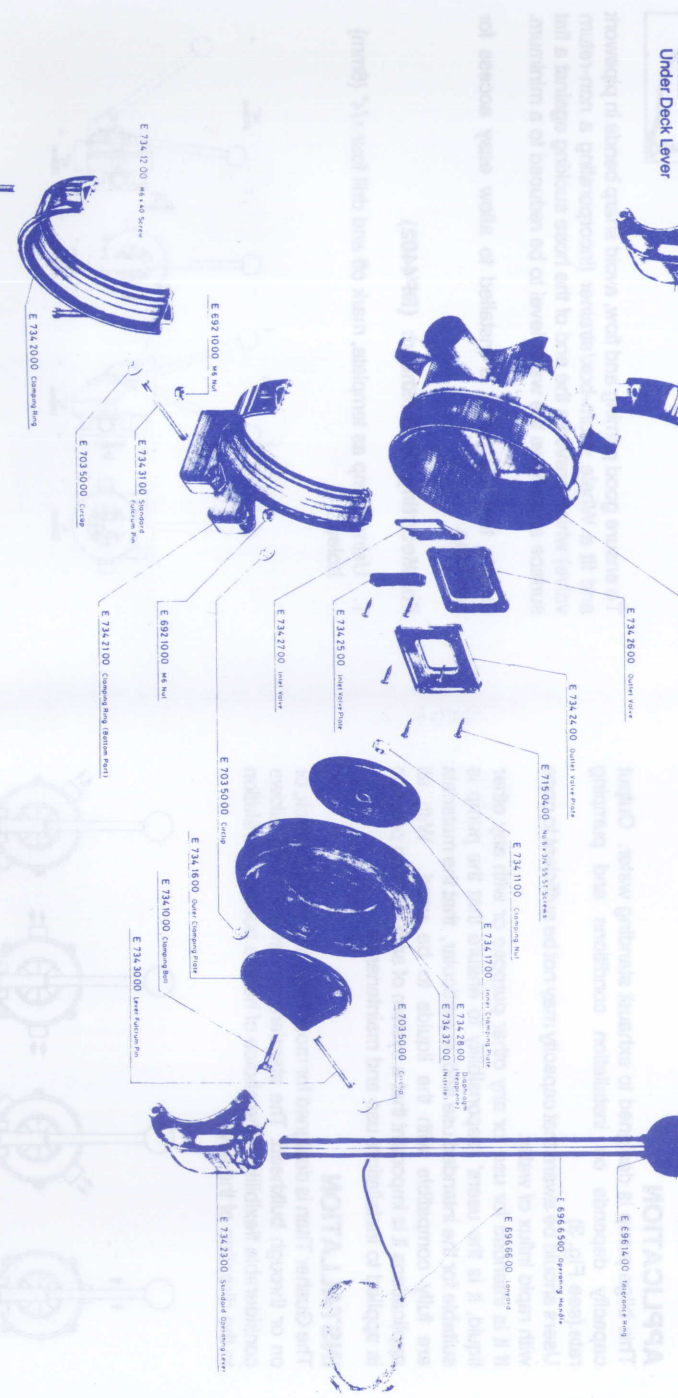

WARRANTY
Whale pumps are guaranteed for 3 years (1 year on rubber parts) from date of purchase against defects in materials and workmanship. If the unit proves faulty, return it to your supplier with proof of purchase and purchase date.
The manufacturer retains the right to repair or replace the unit.
The manufacturer cannot be held responsible for claims arising from incorrect installation, unauthorised modification or misuse of the product.
The above does not affect your statutory rights.



Gusher TITAN Pump

® Whale and Gusher are registered marks of:
MUNSTER SIMMS ENGINEERING LIMITED